

1490

2000

500

850

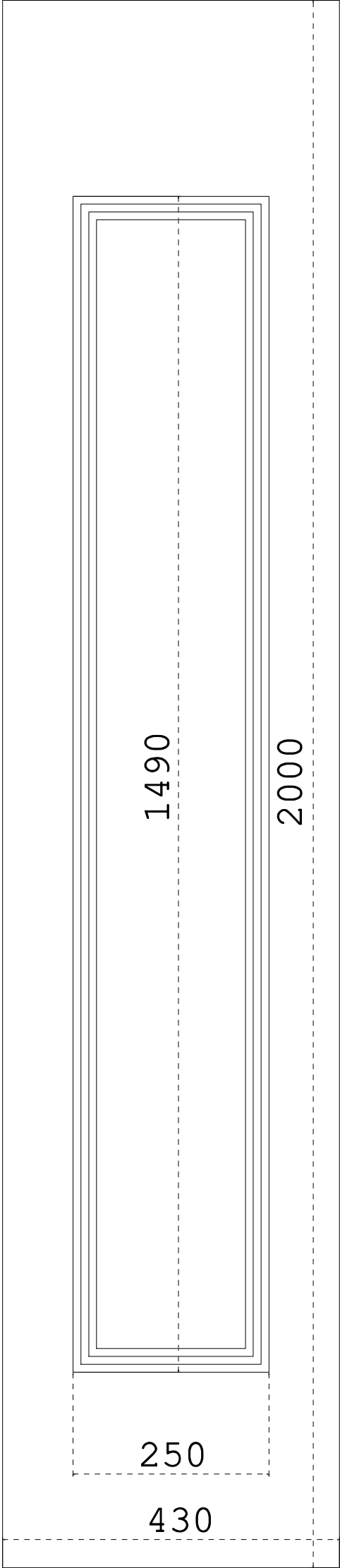

1490

2000

250

430